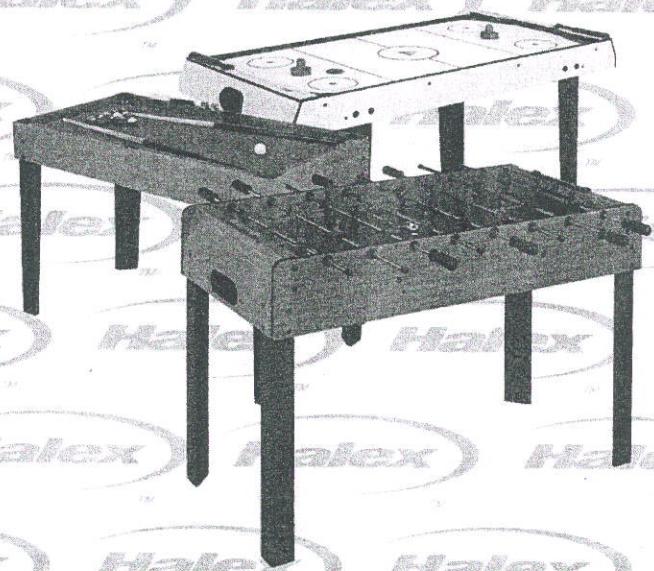



TABLE
Games

Assembly instructions



50888

Billiard Table Game Rules

8-Ball:

All 15 balls are racked with the 8 ball in the middle (many players also alternate stripes and solids at the end of the bottom row). The balls are broken wide open. No matter what happens on the break, the shooter still has his choice of playing stripes or solids. The first player to sink a striped or solid ball is committed to those balls for the remainder of the game. After a player has pocketed all his stripe or solid balls, he may shoot at the 8 ball. The shooter must call the pocket for the 8 ball. If he misses, the game continues. Once the 8 ball is legally pocketed, a winner is declared.

9-Ball:

The 1 through 9 numbered object balls are racked in a diamond shape with the 9 ball in the middle. If a ball is pocketed on the break, the shooter continues his turn. If no balls are pocketed on the break, the next player takes his turn. The shooter must make contact with the lowest numbered ball on the table first; if he does that, any ball that goes in is considered good and he continues to shoot. Whoever legally makes the 9 ball wins the game (the pocket must be called). The penalty for failure to hit the lowest numbered ball first is that your opponent is awarded "ball in hand". The shooter awarded ball in hand may place the cue ball anywhere on the table for his next shot.



LIMITED 90 DAY WARRANTY

This Halex product is warranted to be free from defects in workmanship or materials at the time of purchase for a period of 90 (ninety) days. Certain restrictions apply (see below).

Should any evidence of defects appear within the limited warranty period after the date of purchase, Regent Sports will either send replacement parts or advise of another course of action. A list of replaceable parts can be found on the parts order form page of this manual. Parts not listed on this order form are not replaceable. **Table tops, playing surfaces, and main frames are not replaceable.** This warranty covers normal consumer use and does not cover failures, which result from alterations, accidents, misuse, abuse, or neglect.

For prompt warranty service and special offers, please register your Halex product at our customer service center by visiting our website at: www.regent-halex.com. Enter the following unique registration number followed by the item number of your table found on the cover of this manual: 1ZAK7 _____. You can also register your product on our automated voice recognition system at the toll free number below. You must register your product within 30 days of purchase to be eligible for warranty service. Please make sure to visit our website to order additional parts not covered under the warranty, as well as on-line instruction manuals and new product information. You may also order parts by calling our automated voice recognition system.

A purchase receipt or other proof of date of purchase will be required before warranty service is performed. Requests for warranty service can be provided by e-mailing the customer service department at cstables@regent-halex.com or by calling customer service at:

877-516-9707 (Toll Free)

10:00 AM to 6:00 PM, EST. (Dec. through Jan.)

















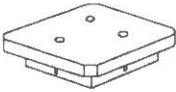



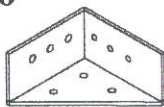
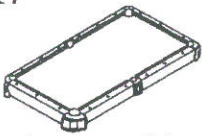
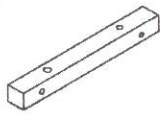

10:00 AM to 5:00 PM, EST. (Feb. through Nov.)

Or send request in writing to:

Regent Sports Corporation
45 Ranick Road
Hauppauge, NY 11788
Attn: Halex Customer Service

This warranty gives you specific legal rights and you may have other rights that vary from state to state.

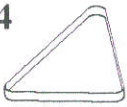
Part List

<p>#1</p>  <p>5/16" bolt 24 pieces</p>	<p>#2</p>  <p>5/16" washer 36 pieces</p>	<p>#3</p>  <p>5/16" bolt 12 pieces</p>	<p>#4</p>  <p>plastic shim 8 pieces</p>
<p>#5</p>  <p>screw 76 pieces</p>	<p>#6</p>  <p>screw 64 pieces</p>	<p>#7</p>  <p>leg plate 4 pieces</p>	<p>#8</p>  <p>leg plate 4 pieces</p>
<p>#9</p>  <p>leg A 8 pieces</p>	<p>#10</p>  <p>leg B 8 pieces</p>	<p>#11</p>  <p>long apron side 2 pieces</p>	<p>#12</p>  <p>short apron side 2 pieces</p>
<p>#13</p>  <p>apron side A 4 pieces</p>	<p>#14</p>  <p>apron side B 2 pieces</p>	<p>#15</p>  <p>end panel 2 pieces</p>	<p>#16</p>  <p>leg bracket 4 pieces</p>
<p>#17</p>  <p>main assembly 1 set</p>	<p>#18</p>  <p>linker panel 4 pieces</p>	<p>#19</p>  <p>tool 1 piece</p>	<p>#20</p>  <p>brush 1 piece</p>
<p>#21</p>  <p>billiard ball 1 set</p>	<p>#22</p>  <p>chalk 2 pieces</p>	<p>#23</p>  <p>cue stick 2 pieces</p>	<p>#24</p>  <p>triangle 1 piece</p>
<p>#25</p>  <p>DVD disk 1 piece</p>			

Step1-Assemble apron pieces # 11 and #12 and attach them to main cabinet frame. Attach each section to the main frame using screws #5.

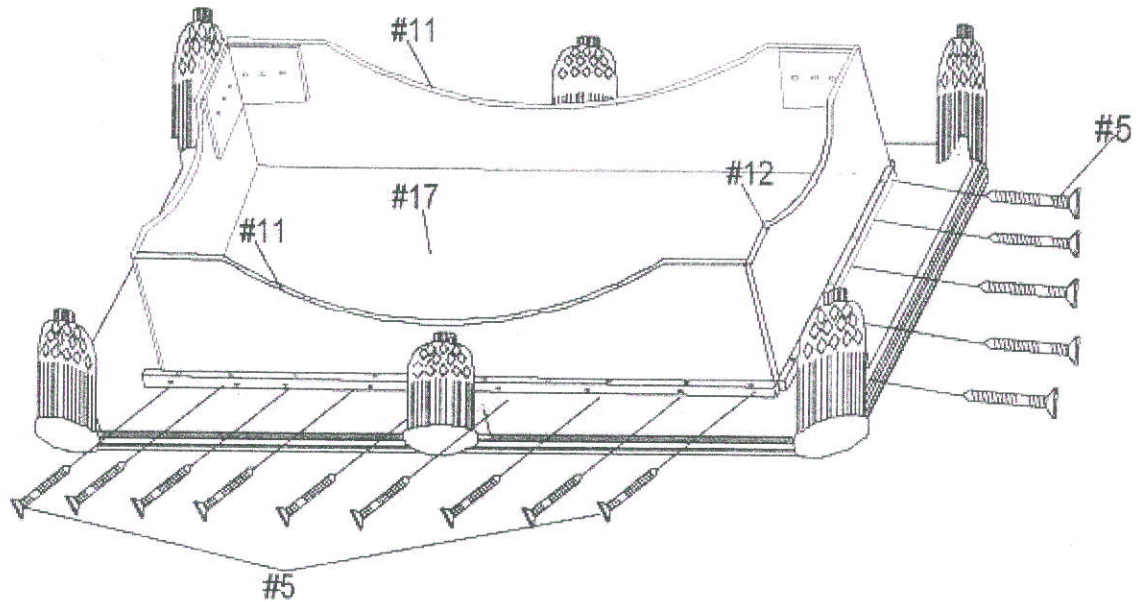

Step2-Next attach leg brackets #16 to each corner using bolts #1 and washers #2. Repeat for each corner.

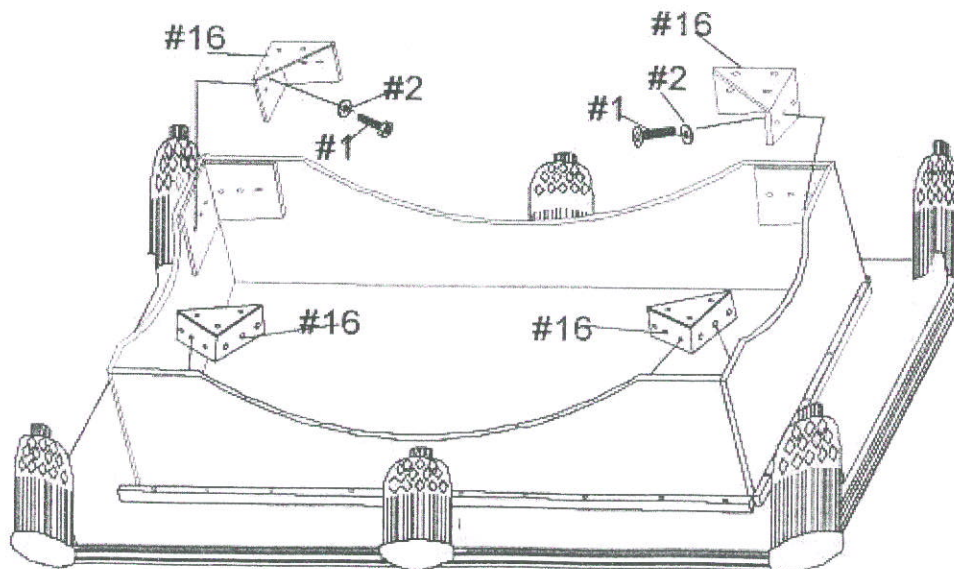

Step3- Attach panels #15 to the bottom of the play surface. Using screws #5. Next attach linker panel #18 to panel #15 and the side panel #11

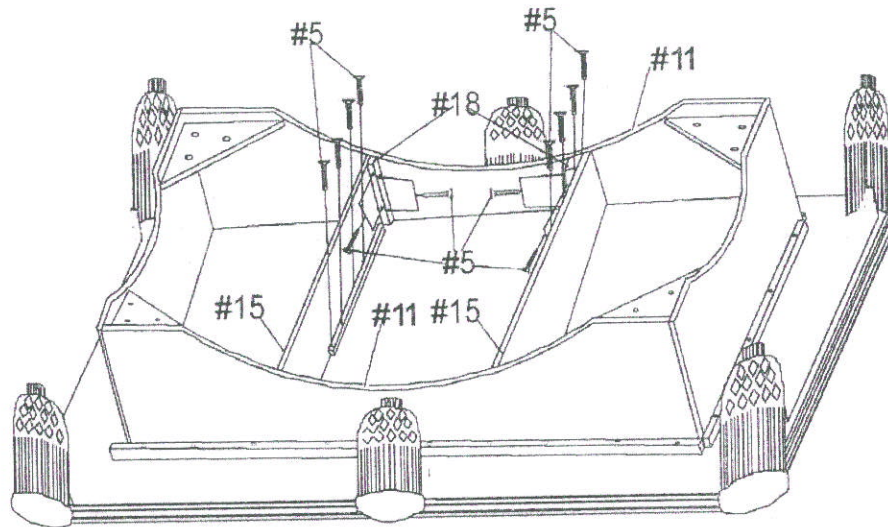

Step4- Attach side aprons #13 and #14 to the main frame set up using screws #5. Please follow diagram for proper placement.

