

60014  
60014-119

TABLE  
**Games**

*Assembly instructions*

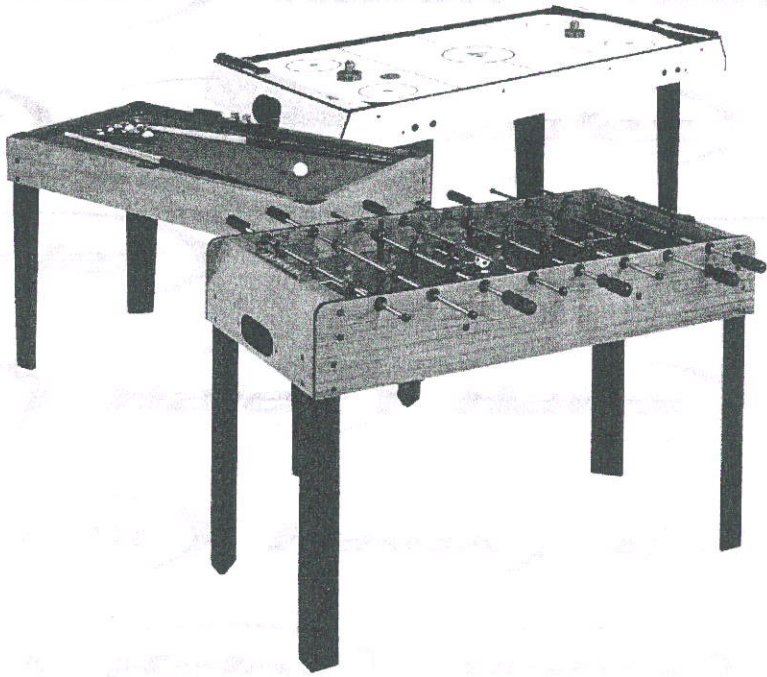

60014

**Should you have a defect or parts issue, please refer to the warranty instructions listed below and contact Regent Sports at our toll free number!!**

### **LIMITED 90 DAY WARRANTY**

This Halex product is warranted to be free from defects in workmanship or materials at the time of purchase for a period of 90 (ninety) days. Certain restrictions apply (see below).

Should any evidence of defects appear within the limited warranty period after the date of purchase, Regent Sports will either send replacement parts or advise of another course of action. A list of replaceable parts can be found on the parts order form page of this manual. Parts not listed on this order form are not replaceable. **Table tops, playing surfaces, and main frames are not replaceable.** This warranty covers normal consumer use and does not cover failures, which result from alterations, accidents, misuse, abuse, or neglect.

For prompt warranty service and special offers, please register your Halex product at our customer service center by visiting our website at: [www.regent-halex.com](http://www.regent-halex.com). Enter the following unique registration number followed by the item number of your table found on the cover of this manual: 1ZAK7 \_\_\_\_\_. You must register your product within 30 days of purchase to be eligible for warranty service. Please make sure to visit our website to order additional parts not covered under the warranty, as well as on-line instruction manuals and new product information. You may also order parts by calling our automated voice recognition system (877) 516-8707.

**A purchase receipt or other proof of date of purchase will be required before warranty service is performed.** Requests for warranty service can be provided by e-mailing the customer service department at [cstables@regent-halex.com](mailto:cstables@regent-halex.com) or by calling customer service at:

**877-516-9707 (Toll Free)**

**10:00 AM to 6:00 PM, EST. (Dec. through Jan.)**

**10:00 AM to 5:00 PM, EST. (Feb. through Nov.)**

Or send request in writing to:

**Regent Sports Corporation**  
45 Ranick Road  
Hauppauge, NY 11788  
Attn: Halex Customer Service

This warranty gives you specific legal rights and you may have other rights that vary from state to state.

## Garantie Limitee DE 90 Jours

Ce produit Halex est garanti contre tout vice de fabrication ou de matériaux au moment de l'achat pendant une période de 90 (quatre-vingt-dix) jours. Certaines limites s'appliquent (voir ci-dessous).

Si un vice apparaissait pendant la période de garantie limitée, Regent Sports enverrait des pièces de rechange où prendrait d'autres dispositions. Une liste des pièces de rechange figure sur la page de commande de pièces détachées de la présente notice. Les pièces ne figurent pas sur ce formulaire ne peuvent pas se remplacer. Les plateaux de tables, les surfaces de jeu et les cadres principaux ne peuvent pas se remplacer. Cette garantie s'applique à une utilisation normale par un particulier et exclut les défaillances consécutives à une modification, un accident, une mauvaise utilisation, un manque de soin ou de la négligence.

Pour obtenir une exécution rapide de la garantie et prendre connaissance des offres spéciales, veuillez enregistrer votre produit Halex auprès de notre centre de service à la clientèle en visitant notre site internet à : [www.regent-halex.com](http://www.regent-halex.com), saisissez le numéro d'enregistrement unique suivant et le numéro de référence de votre table qui se trouve sur la couverture de la présente notice : 1ZAK7\_\_\_\_. Vous pouvez également enregistrer le produit que vous avez acheté sur notre système de reconnaissance vocale au numéro gratuit indique ci-dessous. Vous devez enregistrer le produit dans les 30 jours qui suivent la date d'achat pour pouvoir bénéficier du service de garantie. Ne manquez pas de visiter notre site internet pour commander des pièces non couvertes par la garantie ainsi que pour trouver des notices en ligne et les informations concernant les produits nouveaux. Vous pouvez également commander des pièces détachées en utilisant notre système de reconnaissance vocale automatisé.

Un reçu ou autre preuve d'achat sera exigé avant d'exécuter tout recours à la garantie. Vous pouvez faire parvenir les demandes d'exécution de la garantie par courrier électronique en les adressant au service à la clientèle à [ctables@regent-halex.com](mailto:ctables@regent-halex.com) ou en appelant le service à la clientèle au :

877-516-9707 (Toll Free)

10 h à 18 h, HNE. (Décembre à Janvier)

10 h à 17 h, HNE (Février à Novembre)

Ou en envoyant la demande par écrit à :

Regent Sports Corporation

45 Ranick Road



















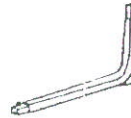

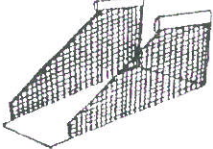
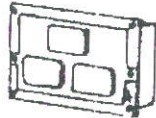
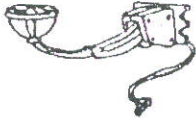

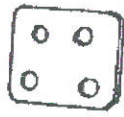

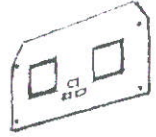
Hauppauge, NY 11788

Attn: Halex Customer Service

Cette garantie vous donne des droits spécifiques face à la loi et il se peut que vous en ayez d'autres, variables selon les états.

# 60014 PARTS LIST & ASSEMBLY

## 1. PARTS LIST

<p>1</p>  <p>NET HANGER TUBE 1-1/8" DIA. 2PCS</p>	<p>2</p>  <p>VERTICAL BOARD MOUNTING SUPPORT TUBE 1-1/8"DIA. 2PCS</p>	<p>3</p>  <p>VERTICAL SUPPORT TUBE 1-1/8" DIA. 2PCS</p>	<p>4</p>  <p>LEFT HORIZONTAL FRAME BRACE, SQUARE 25X25MM 1PC</p>	<p>5</p>  <p>RIGHT HORIZONTAL FRAME BRACE, SQUARE 25X25MM 1PC</p>
<p>6</p>  <p>ANGLE TOP FRAME SUPPORT TUBE 1-1/8"DIA. 2PCS</p>	<p>7</p>  <p>ANGLE BOTTOM FRAME SUPPORT TUBE 1-1/8"DIA. 2PCS</p>	<p>8</p>  <p>MIDDLE RAMP SUPPORT SQUARE TUBE 25X25MM 2PCS</p>	<p>9</p>  <p>FRONT RAMP SUPPORT SQUARE TUBE 25X25MM 2PCS</p>	<p>10</p>  <p>FRONT HORIZONTAL RAMP SUPPORT SQUARE TUBE 25X25MM 1PC</p>
<p>11</p>  <p>HORIZONTAL CROSS BRACE 1/2"DIA. 1PC</p>	<p>12</p>  <p>BALL RAMP WITH SIDE NETTING 1PC</p>	<p>13</p>  <p>ELECTRONIC SCORER 1PC</p>	<p>14</p>  <p>SWITCH AND PADDLE ASSEMBLY 2PCS</p>	<p>15</p>  <p>110V ADAPTER 1PC</p>
<p>16</p>  <p>RIM ASSEMBLY 2PCS</p>	<p>17</p>  <p>RIM SUPPORT PLATE, METAL 2PCS</p>	<p>18</p>  <p>INFLATION PUMP WITH NEEDLE 4" 1PC</p>	<p>19</p>  <p>NET 2PCS</p>	<p>20</p>  <p>BACKBOARD 1PC</p>
<p>21</p>  <p>M6 WASHER 76PCS</p>	<p>22</p>  <p>M6X25MM BOLT 20PCS</p>	<p>23</p>  <p>M6X35MM BOLT 2PCS</p>	<p>24</p>  <p>M6X40MM BOLT 12PCS</p>	<p>25</p>  <p>M6X45MM BOLT 4PCS</p>
<p>26</p>  <p>SMALL WING NUT 34PCS</p>	<p>27</p>  <p>FOLDING LOCK PIN 2PCS</p>	<p>28</p>  <p>SIZE#3 BASKETBALL 7"DIA. 4PCS</p>	<p>29</p>  <p>LARGE WING NUT 4PCS</p>	

## PART2. ASSEMBLY

### ① FIG.

**Step 1** Attach both Rims #16 and Rim Support Plate # 17 to Backboard #20 using Bolts #22, washers #21 and Wing Nuts #26.

Make sure that you use washers #21 on both sides of the backboard

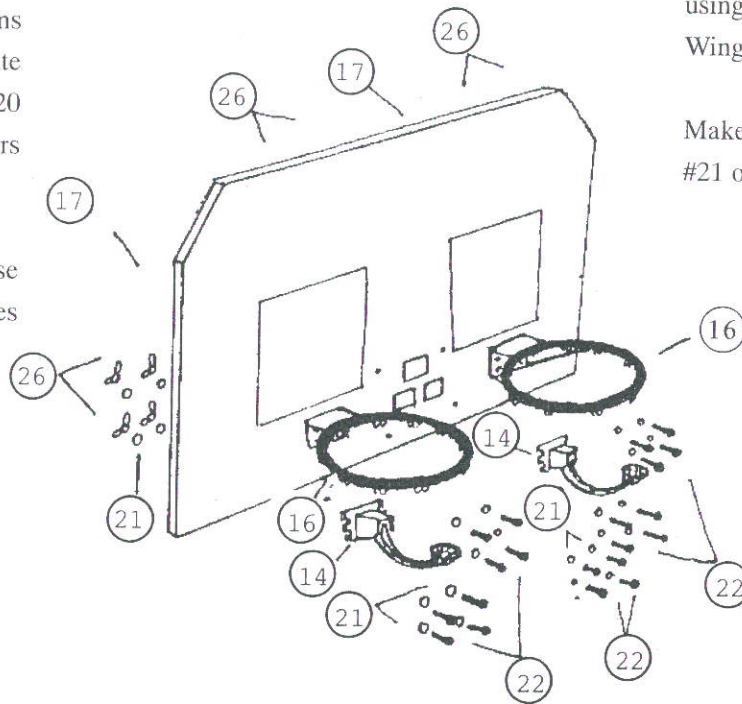

**Step 2** - Attach both Paddle Switches # 14 to the Backboard using Bolts #22, washers #21 and Wing Nuts #26.

Make sure that you use washers #21 on both sides of the backboard

### ② FIG.

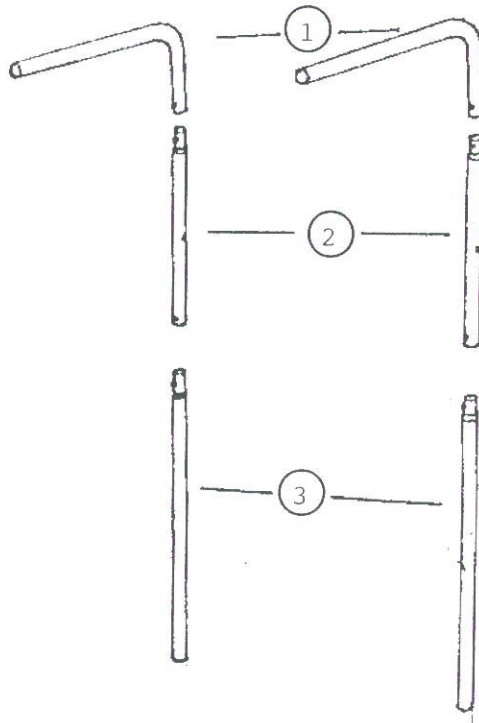

**Step 3** Attach Net Hanger Tubes #1, Vertical Board Mounting Support Tube #2 and Vertical Support Tube #3.

Simply snap each tube together.

**③ FIG.**

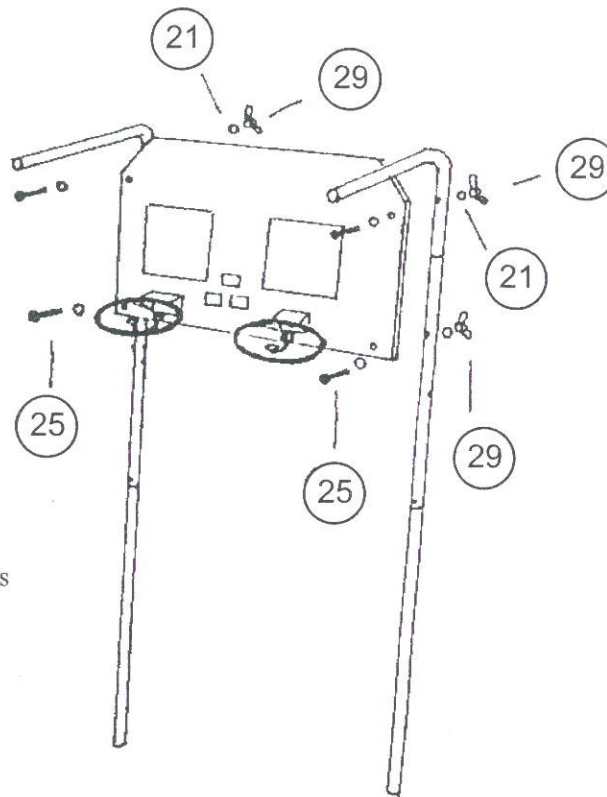

**Step 4** Attach Backboard set up to the Support Tube assembly completed in previous step using Bolts #25 Washers # 21 and Large Wing Nut # 29

**Note:** Having 2 people makes assembly easier but is not required.

**④ FIG.**

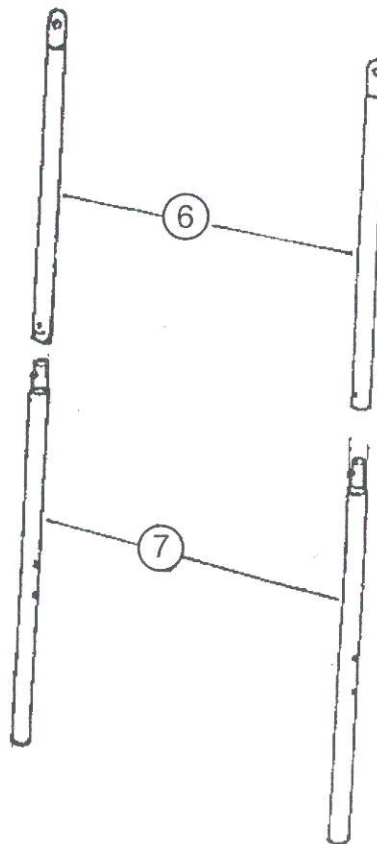

**Step 5** Attach Top Angle Support Tubes # 6 to Bottom Angle Support Tube # 7.